

Do The Right Thing!

***A North Atlantic Right Whale
Activity Guide for Kids***

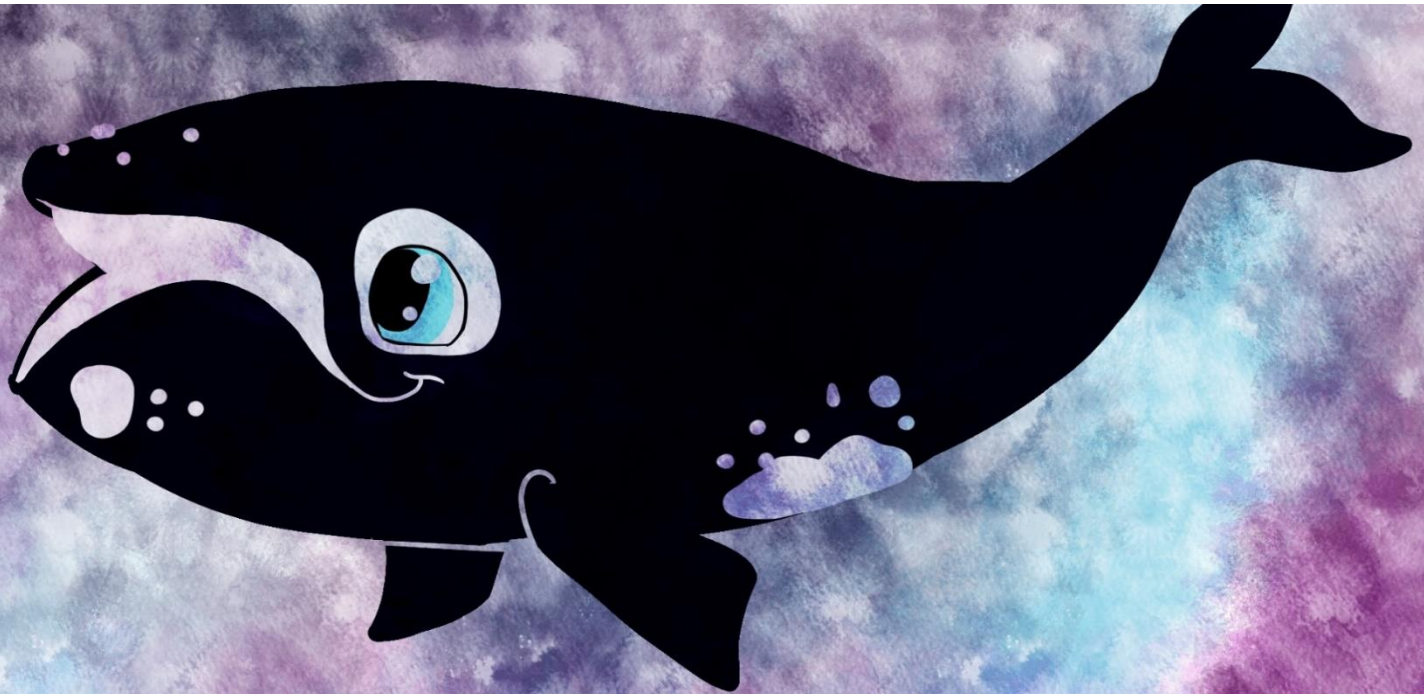

North Atlantic Right Whales

North Atlantic Right Whales are some of the most **endangered** whales on earth!

It is hard to get an exact count, but in 2021, researchers estimated there were less than 350 left. Some scientists think these whales could be **extinct** within 20 years. How old will you be in 20 years?

North Atlantic Right Whales can be found in the Atlantic Ocean (as far North as Canada and as far south as Florida). They are **baleen** whales, which means they have comb like plates instead of teeth. These fringed plates are made from keratin (like your fingernails) and help whales trap their food and let out seawater. It is almost like straining spaghetti.

Unlike some whales, North Atlantic Right Whales do not have **dorsal fins**. A dorsal fin is a triangle shaped body part on some marine animal's backs that help them balance (think of sharks). They have robust black or dark gray bodies, with rough white patches called '**callosities**' on their heads. Some Right Whales also have white markings on their bellies.

Even though Right Whales look very similar, scientists can tell the whales apart from their callosities and special markings. Every whale is different! What makes you different from members of your family? What makes you the same?

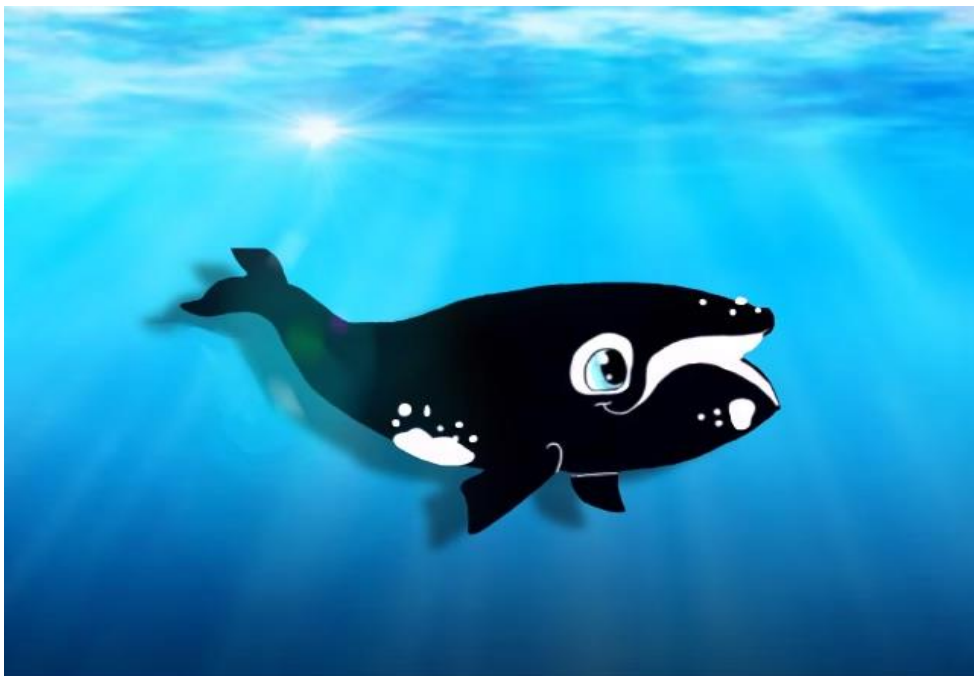

Did you know that North Atlantic Right Whales have Names?

That's Right! There is Gully, Sebastian, Lone Star, Sundog, Owl, Cottontail ... even Popcorn!

Researchers can tell whales apart by their markings and white bumps on their heads (Callosities)

What would you name these whales?

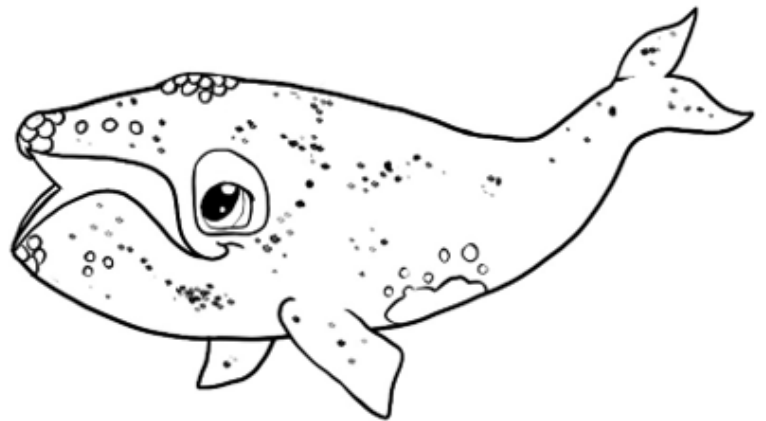
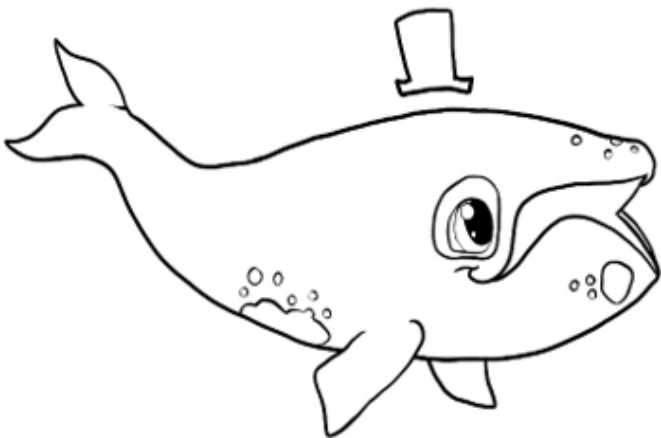
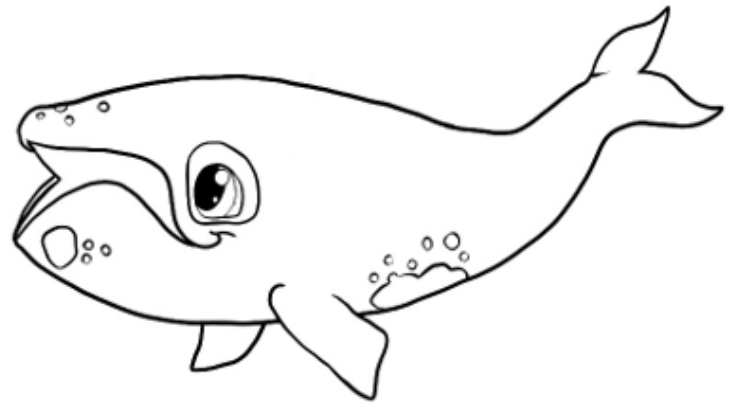
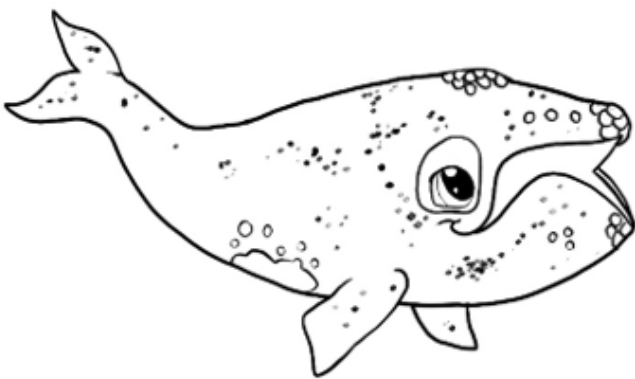

North Atlantic Right Whale Babies

A baby whale is called a calf. North Atlantic Right calves are born in December through March in the Southeastern part of the United States (North Carolina, South Carolina, Georgia, and Florida). Mother Right Whales carry one calf at a time for 12 months, and nurse their baby for 12 months after they are born.

In 2021, 19 baby North Atlantic Right Whales were born! That is GREAT news! In 2020, only 10 babies were born... and in 2019 only 7 were born!

Even though researchers are very happy when a new whale is born, they are still very worried about these whales going extinct!

North Atlantic Right Whales can have babies all their lives, but the moms need to rest at least three years in between having each calf. Instead of having a baby every three years, many whales are now having one calf every seven to ten years!

This worries researchers a lot. Many researchers believe that boat traffic and whales getting tangled in fishing gear may be getting in the way of calves being born.

Boats and fishing gear pose some of the greatest dangers to North Atlantic Right Whale survival!



A baby Right Whale is called a calf. The calves stay very close to their mothers. People and boats should never go near a mother and her calf (even though they are cute)! What could happen if a boat got too close?

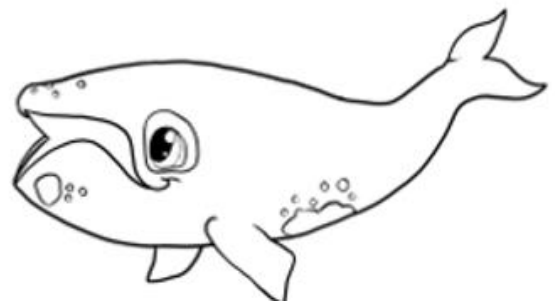
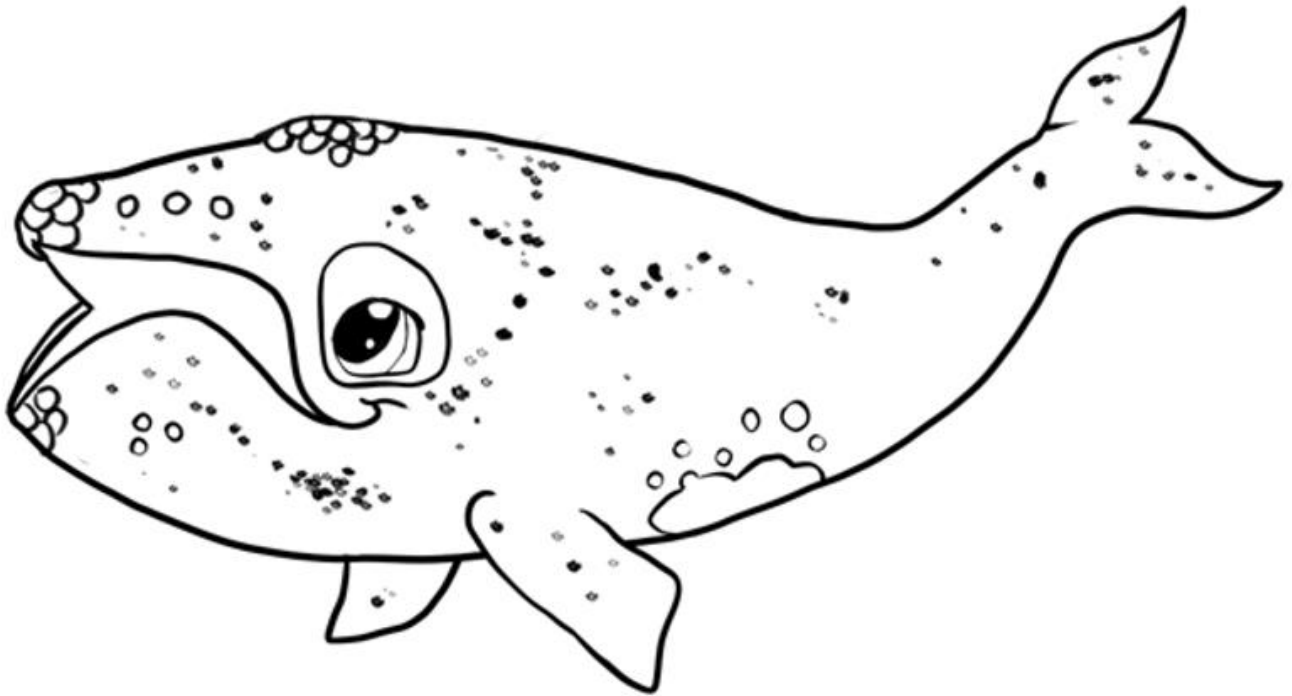

What Does 'Entanglement' Mean?

One of the biggest threats to North Atlantic Right Whales is entanglement- or getting tied up in fishing ropes, nets and other gear. The Right Whales most often get tangled in pot gear designed to catch lobster and crabs.

Researchers think that 85 out of every 100 North Atlantic Right Whales have been entangled in fishing gear at least one time in their lives. Many of them have been entangled two or more times in their lives!

Scientists have seen large scars on whales caused by ropes and fishing lines. The fishing gear can cut deeply into a whale's body, causing cuts that can hurt or even kill the whales. Sometimes whales get stuck in gear and cannot get free for months or even years. Carrying around fishing gear can weigh them down and slow their swimming. They may eat less food because it takes more energy to feed. It sometimes stops whales from having calves. Being tangled for a long time can also stress a whale and cause damage to their heart and immune system (which fights off germs).

If you see a whale caught in ropes or other fishing gear, do not approach it. For the safety of the whale (and you) it is against the law for anyone except trained responders to assist in freeing the whale. Call the whale hotline at [1-866-755-NOAA \(6622\)](tel:1-866-755-NOAA) and let them know the exact location of the whale and any details that you can observe from a safe distance.



Can you help the baby North Atlantic Right Whale find the way out?

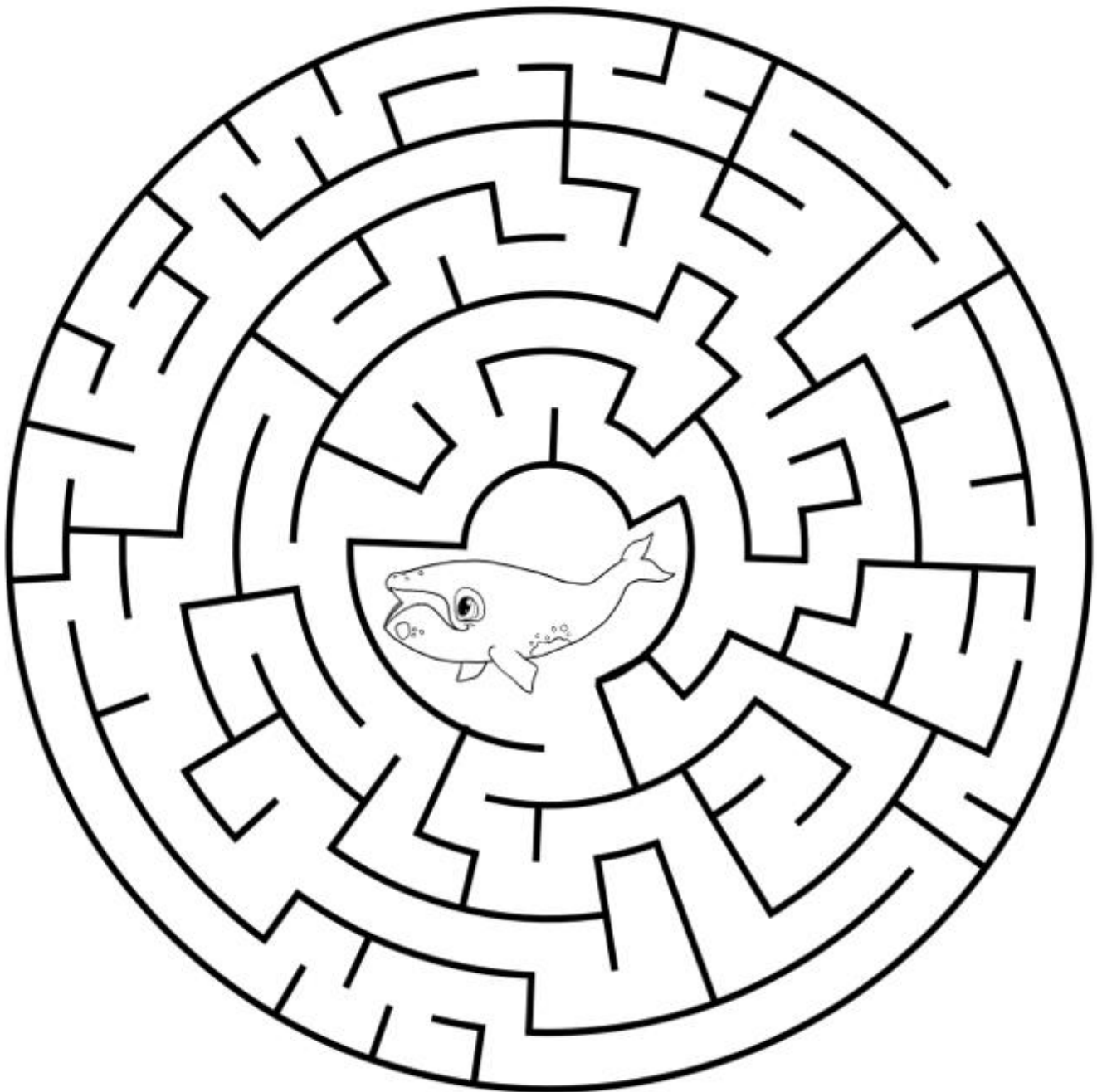

North Atlantic Right Whales and Boat Strikes

The other major threat to North Atlantic Right Whales is getting hit by boats!

Right Whales swim very slowly, and they stay close to the surface. It is very hard for them to avoid being hit by a boat that is moving towards them.

Large boats can easily kill a whale, but small boats can too. It is the responsibility of people (not whales) to avoid crashes.

The important thing for boats to remember is to slow down! Often boats are going so fast that they do not have time to turn or stop to avoid hitting a whale. When a boat is going under the speed of 10 knots, the chances of a whale surviving a boat strike is much higher. Even if a whale survives, it can still have very bad injuries. No one wants that!

The best thing to do to avoid hitting a whale is to stay far away! The law says that boats need to stay the length of about 5 football fields away from North Atlantic Right Whales.

If you see a Right Whale, you can report it on the [Whale Alert App](#) (ask your parents to download it on your phone). This will notify other boat operators that there are whales in the area!

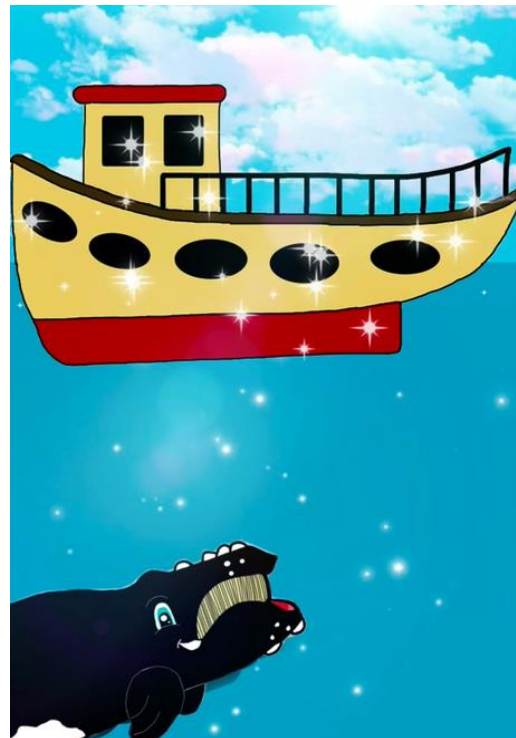

Other Dangers to North Atlantic Right Whales

Although entanglements and ship strikes are the biggest threats facing North Atlantic Right Whales, they are not the only threats.

- **Whaling**

Right Whales almost went extinct in the early 1900's because of whale hunting (called whaling). Whalers called them the "right" whale to hunt because they swim very slow and close to the shore, making them easier to catch. It has been illegal to hunt Right Whales for almost 90 years, but they are still trying to recover.

- **Noise Pollution**

Human made noise from things like boats, construction, and drilling for oil can disturb normal whale behavior (such as resting, finding food, and even having calves)! It can also make it harder for whales to communicate with each other and pay attention to their surroundings. This can cause danger, stress, and confusion.

- **Water Pollution**

Chemicals, plastics, and trash are hurting all ocean life. Single use plastic items (like straws and grocery bags) are ending up in the ocean and can be mistaken for food. This can make whales and sea animals sick and be a choking hazard. Chemicals such as detergents and fertilizer can get into the water and can poison marine animals and the food they eat.

- **Ocean Warming**

The oceans are getting warmer at a quick rate. When the temperature of the sea changes, the whale's food may move to cooler waters or be harder to find. If North Atlantic Right Whales need to move further to find food, it may lead them to areas that are busier and not as safe.

What things can hurt a North Atlantic Right Whale?

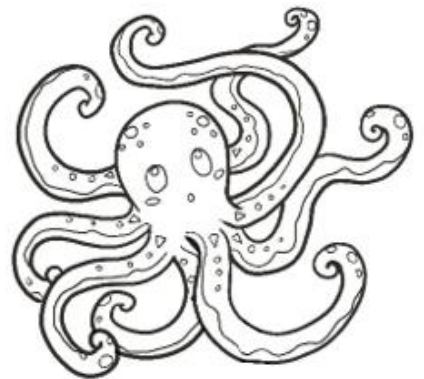
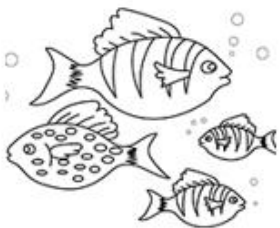
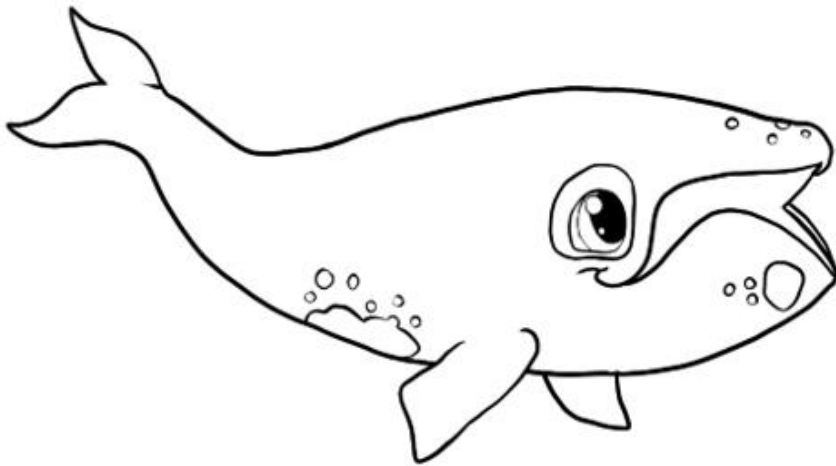
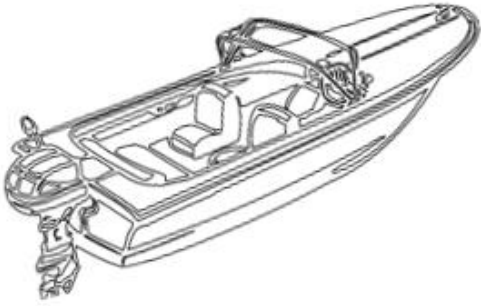

What is being done to help North Atlantic Right Whales?

North Atlantic Right Whales are protected by both the Endangered Species Act and the Marine Mammal Protection Act. The Endangered Species Act makes it against the law to hurt, disturb or kill an endangered animal and provides protection for their surroundings. The Marine Mammal Protection Act makes it against the law to hunt, capture, hurt or bother [marine mammals](#).

Seasonal Management Areas (SMA's) have been set up at certain times of the year in areas where North Atlantic Right Whales are known to swim. All boats over 65 feet in length need to travel slow (10 knots or below) to avoid striking a whale. The slower a boat is moving, the better chance a whale has to survive if it is hit. Boats smaller than 65 feet are asked to go slow too.

All people and vessels must stay 500 yards away from North Atlantic Right Whales. Any vessel (aircrafts, boats, even small kayaks) within 500 yards must immediately leave at a slow speed.

State and Federal lawmakers have addressed changes to fishing gear. "Weak ropes" have been introduced that are designed to break if a whale gets tangled. These ropes may be too strong for a tangled whale calf to break free of. Many organizations are calling for "ropeless" fishing gear that would get rid of all fishing lines and ropes in the water.

Some fishing grounds have been closed to reduce the chances of whales getting tangled in fishing gear and disturbed by boats.



Can you count how many North Atlantic Right Whales are left today?

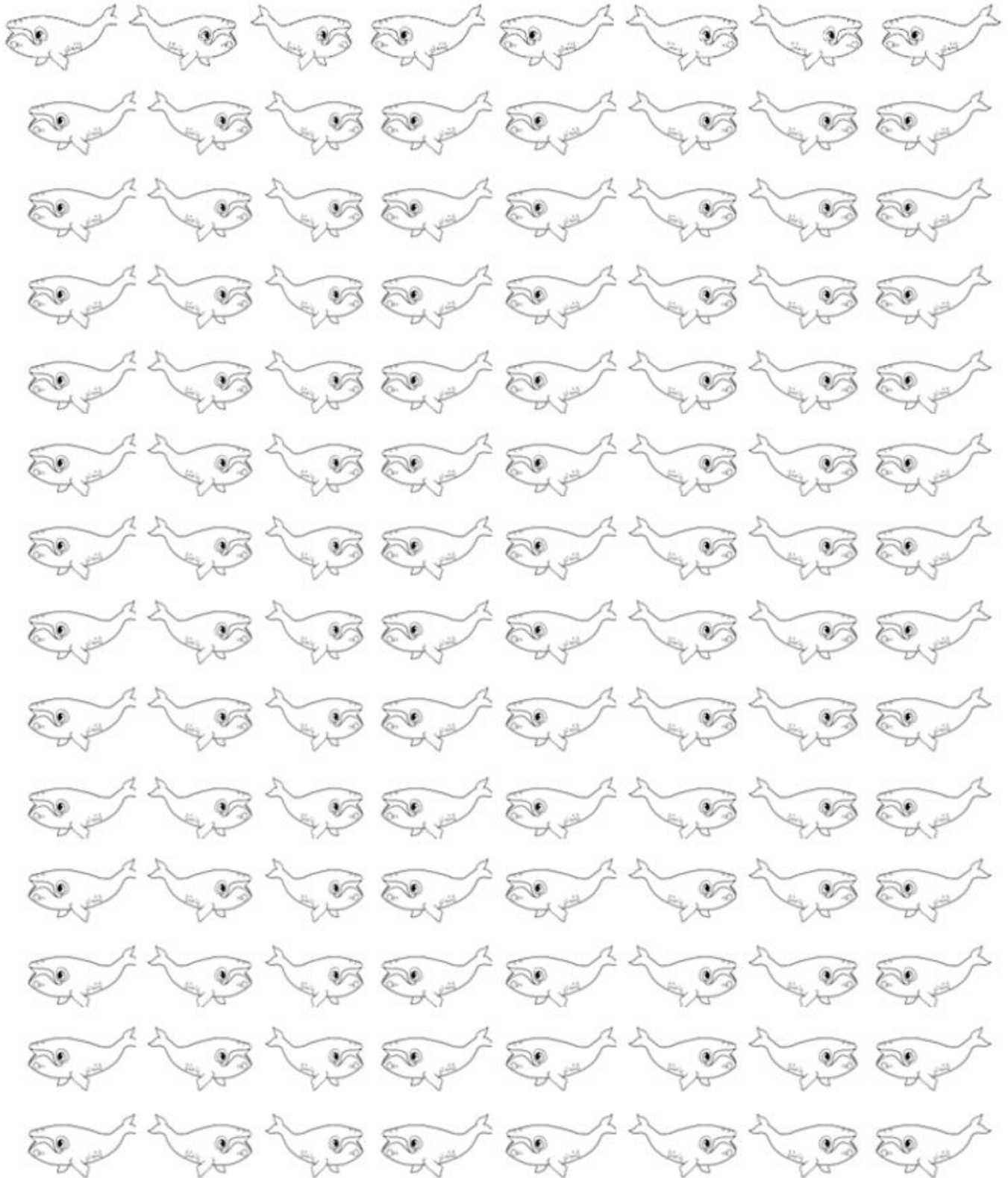

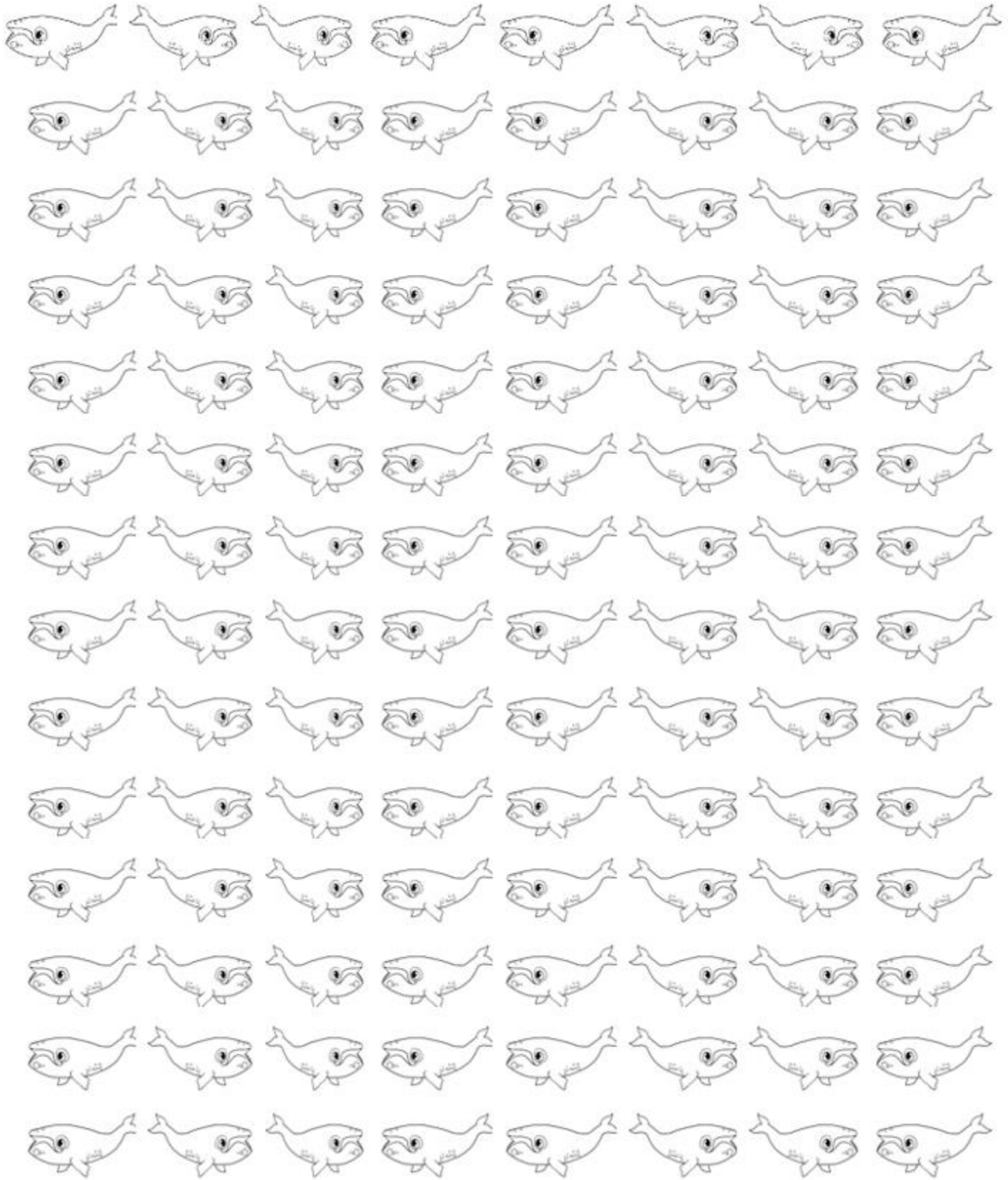

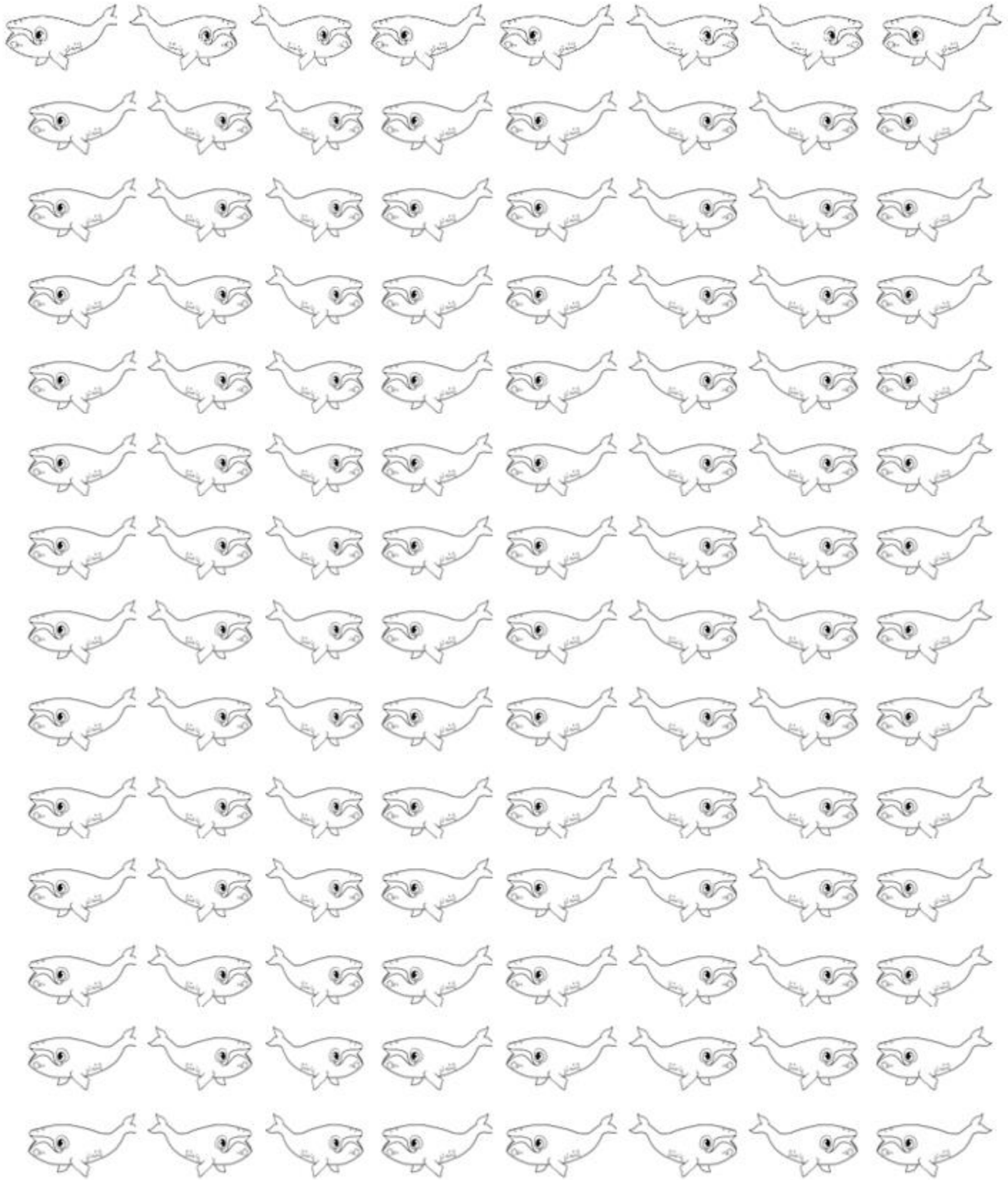

Other Right Whales Around the World

Did you know that North Atlantic Right Whales are not the only Right Whales in the world?

Pacific Northern Right Whales are very rare and endangered as well. These whales live in the North Pacific, and have been spotted in waters near Alaska, Hawaii, Japan and Russia.

Southern Right Whales can be seen in places such as Australia, Argentina, South Africa, South America, and even sub-Antarctic oceans.

In South Africa, a very rare whale named Neptune was recently born! Neptune is a Brindle Southern Right Whale- meaning she was born almost completely white with a pattern of dark spots. Brindle Southern Right Whales are extremely rare, and almost all brindle calves are boys. Neptune is believed to be a girl- and one of the rarest whales in the world!



Right Whales are not the only cool whales in the ocean! Here are just a few of many more!!! Do you have a favorite?

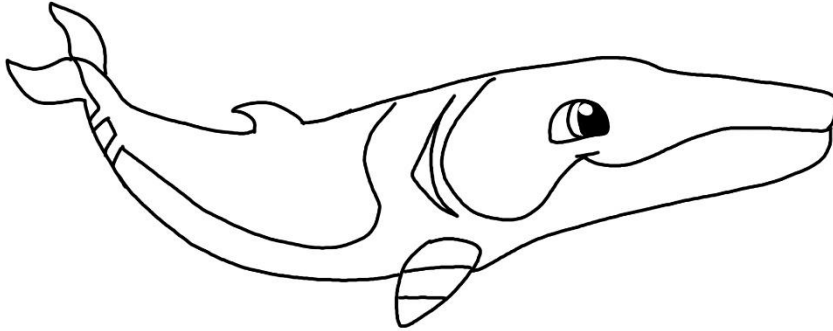

***Minke
Whale***

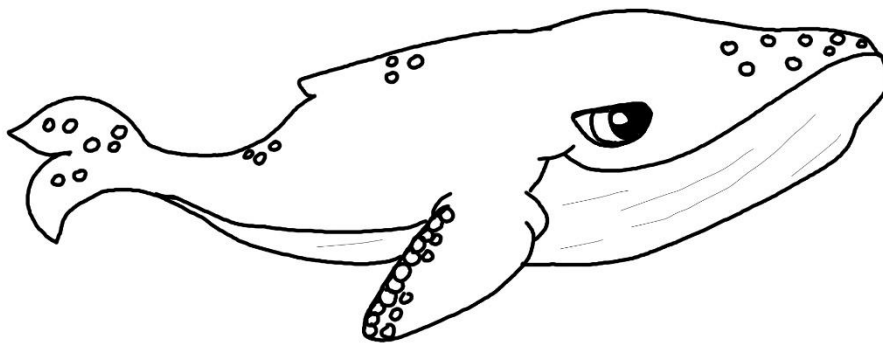

***Humpback
Whale***

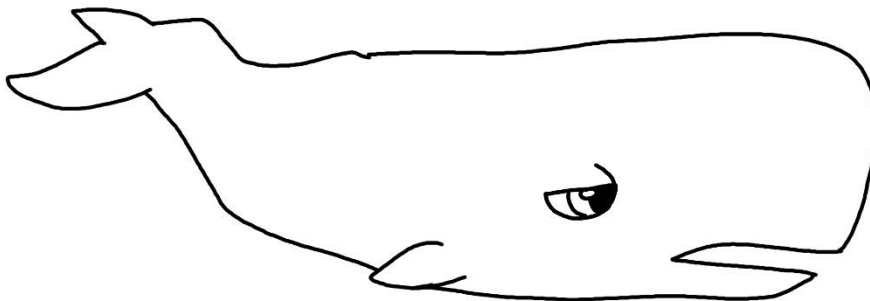

***Sperm
Whale***

Saving Whales Matter

Whales are such beautiful and amazing creatures! But did you know that whales help the oceans and the environment?

Humans and whales need oxygen to breath. Tiny ocean plants called **phytoplankton** give off oxygen. When a whale poops, it releases nitrogen and important minerals like iron into the water. This helps the phytoplankton grow- so more oxygen is produced. Phytoplankton help feed fish and other ocean creatures. Everything is connected!

Whales are also very important to the ocean food chain. Right Whales feed on tiny animals called zooplankton and small **crustaceans**. Crabs and lobsters are popular crustaceans that you may have seen. Right whales feed mainly on crustaceans called copepods and krill. While their food is very tiny, they can eat thousands of pounds of it in one day! Other whales may eat fish, mammals, and even other whales!

Without whales as part of the food chain, the creatures that they eat would multiply. Over time, this would change the **ecosystem**- (an ecosystem is all living and nonliving things in one area). Other plants and animals depend on their ecosystem to survive. Any changes in the ocean's ecosystem could cause other sea creatures to go extinct!

Without whales, the whole ocean would be thrown off balance. This could affect the entire earth!

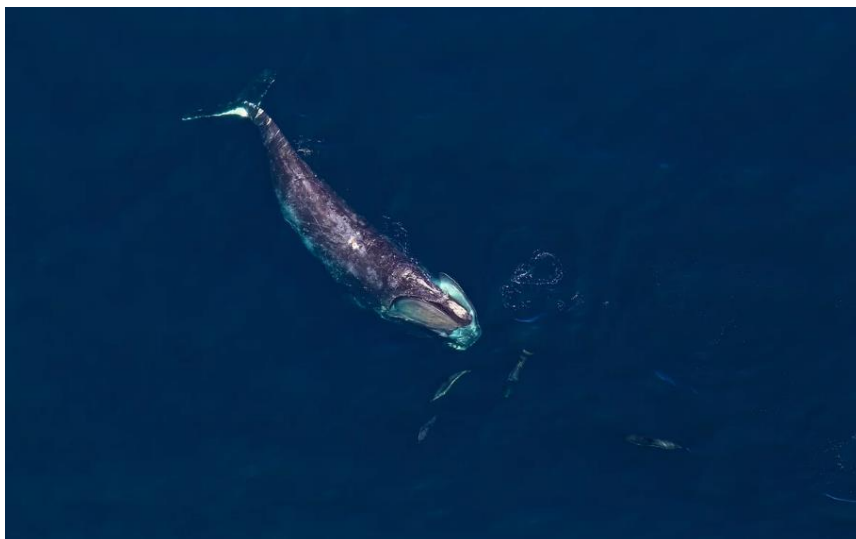

What Can you do to Help North Atlantic Right Whales?

The future of the North Atlantic Right Whale depends on all of us! Because there are so few left, the loss of even one could mean extinction.

One of the best things that you can do is learn more about Right Whales and share your knowledge. Get your friends and family interested. Send letters, postcards, or letters to politicians in your state. Ask your teachers and group leaders to get involved.

If you are in a boat, remind the driver to go slow and look out for whales. Look out yourself too! See if you can see sprays from a whale's blow, or objects floating on the surface that may be whales! Remember to stay at least 500 yards away from Right Whales and never approach a mother and baby!

Ask your family to support fishing companies that use gear with no ropes!

Keep the ocean clean! Avoid single use plastics (like straws and balloons) which can hurt sea life. Make sure that you recycle and reuse.

Organize a beach clean-up... or clean up by yourself! Every piece of trash that you pick up is a piece of trash that does not go into the ocean!

Ask Questions! Share knowledge! Get involved! Look for solutions! Your input matters!

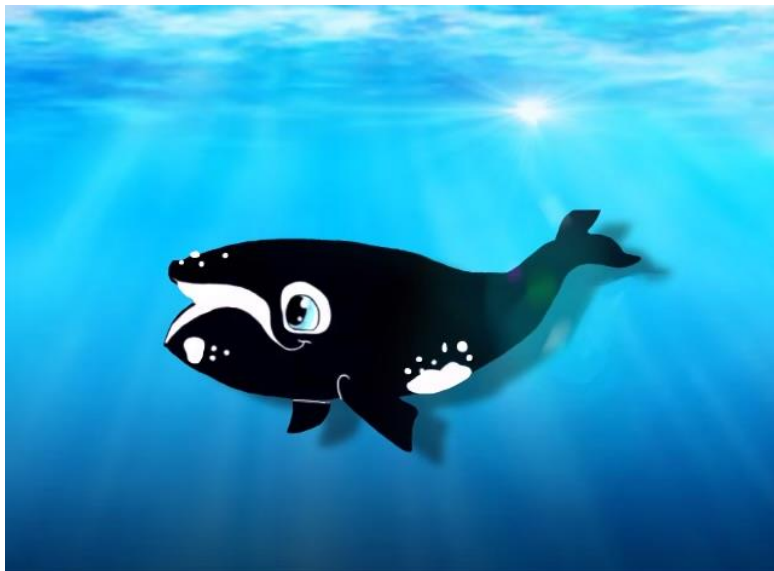

Can you spot the differences below?

KEEP OUR OCEANS CLEAN



KEEP OUR OCEANS CLEAN



More Cool Right Whale Facts... Did you know?

- Whales and dolphins have blow holes on the top of their heads which help them breathe air. Some whales have one blowhole, and some have two! You can often see a spray of misty air coming out of a whale's blowhole. This is called the whale's blow. Right Whales have two blow holes and produce a V-Shaped blow!
- Researchers think that Right Whales can live for 70 years or longer (maybe even up to 100). However, many North Atlantic Right Whales are only living 45 to 65 years. This is because many die of accidental causes instead of old age. How can we help prevent accidents?
- Scientists can tell how long a Right Whale lived by studying the whale's ear wax!
- Right whales grow to about 50 feet long (That is 50 rulers). They can weigh 70 tons!
- Right Whales swim very slowly- about 6 miles an hour.
- Right Whales can spend up to 20 minutes under the water.
- Right Whales are usually found alone or with small groups.
- Right Whales may not be afraid to approach boats. This puts them in danger of being hit. It is people's responsibility to keep boats a safe distance away from the whales.
- Right Whales used to be hunted for their meat and blubber (which was boiled to make oil).
- Right whales were almost hunted to extinction. They are very strong, and scientists hope that this strength (along with help from us) can save them from extinction again!

Glossary

Baleen- Some whales have teeth (like Belugas and Sperm Whales). Other whales (such as Right Whales and Humpbacks) have fringe like plates called **baleen** instead of teeth. The baleen acts like a sift and filters out seawater while trapping food!

Callosity- **Callosities** are thick, white patches of skin found on Right Whales' heads. These callosities can help researchers identify whales.

Cetacean- **Cetaceans** are members of a marine mammal group that include whales, dolphins and porpoises. (Seals, sea lions and walruses are known as pinnipeds).

Crustacean- Crustaceans are a class of sea animals with hard outer shells. Crabs, lobsters, shrimp, and krill are all **crustaceans**.

Dorsal fin- A dorsal fin is a triangle shaped body part on the backs of many sea creatures (such as dolphins, sharks, and some whales). **Dorsal fins** help to balance fish and marine mammals so they don't roll over, and can help them control movements.

Ecosystem- An ecosystem is a delicate balance of an environment and all the living things that share that environment. **Ecosystems** can contain living plants and animals, and non-living objects like rocks, water, and even air!

Endangered- Animals that are considered **endangered** are at risk of becoming **extinct** (no longer existing anywhere on this earth)! Endangered animals are protected under the **Endangered Species Act** of 1973. Can you research how many animals are covered under the Endangered Species Act?

Mammals- Mammals are warm blooded animals that breathe air, have hair, and nurse their babies. **Marine mammals** are mammals that depend on the ocean to survive (even if they live on land-close to the ocean). Whales, dolphins, seals, sea otters and even polar bears are all marine mammals.

Plankton- Plankton are very small plants and animals that float in the water. Many **plankton** can only be seen under a microscope. **Phytoplankton** are tiny plants or plant like organisms. **Zooplankton** are small animals.

North Atlantic Right Whales Resources

There are many organizations working to save the North Atlantic Right Whale. Below are just a few to get you started on your quest for more knowledge!

- NOAA (National Oceanic and Atmospheric Administration) fisheries require all vessels (boats, aircraft, drones, even surfboards) to stay 500 yards (5 football fields) away from North Atlantic Right Whales. If you see anyone disturbing a North Atlantic Right Whale (Including getting too close or going too fast) call the NOAA Fisheries Enforcement Hotline at [\(800\) 853-1964](tel:8008531964). The hotline is open 7 days a week, 24 hours a day!
- The Center for Coastal Studies in Cape Cod, Massachusetts is one of the best research facilities for North Atlantic Right Whales. They have planes flying over the ocean to spot whales and warn boats in the area. They also hold beach walks in March and April when there is a chance to see a Right Whale while standing right on land! Bring your binoculars!
- The Anderson Cabot Center for Ocean Life has research programs to help understand how humans are impacting North Atlantic Right Whales. Their work on the North Atlantic Right Whale Catalog helps to identify and study whales over long periods of time.
- Organizations such as the Whale and Dolphin Conservation (WDC), Defenders of Wildlife, and the International Fund for Animal Welfare (IFAW) are asking congress to approve the Save Right Whales Act, which would provide 50 million dollars over 10 years to North Atlantic Right Whale conservation efforts.

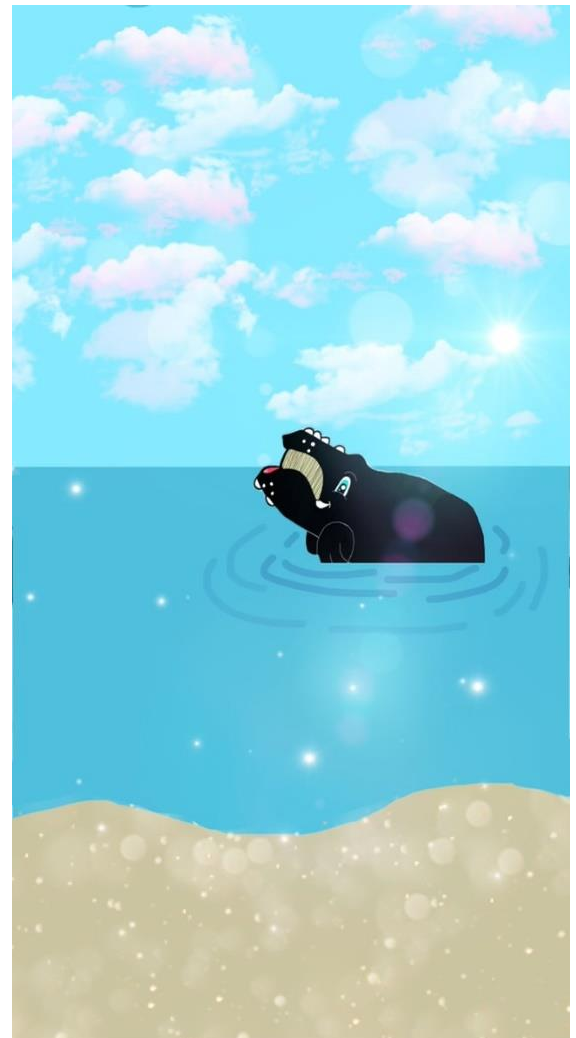

This certifies that _____



*promises to be a Right Whale Hero and will
learn more about helping whales and other ocean
friends all over the world!*

★ *Signed* _____ *Date* _____



North Atlantic Right Whale



Southern Right Whale